



LiFePO4 Battery Specification



ENGINEERED
IN THE USA

LBS-3660

Voltage: 38.4V | Capacity: 60 Ah | Energy: 2304 Wh



36V60AH Battery Specification

Nominal Voltage	38.4V
Charge Voltage	43.2V±0.2V
Cut-off Voltage	30V
Nominal Capacity	60Ah (at 0.5C rate discharge after standard charge)
Minimum Capacity	58Ah (at 0.5C rate discharge after standard charge)
Pack Weight	Approximately 20kg/44lb
Delivery Voltage	39 ~ 40.6V
Battery Dimension	532 (L) x 207 (W) x 215 (H) mm 20.94 (L) x 8.14 (W) x 8.46 (H) in
Case Color	Black
Case Material	ABS
Cell Type-Chemistry	Prismatic Cell-LiFePO4
Standard Charge Current&Voltage @ Temp: 0~45°C	Step 1: 0.5CC charge to 43.2V; Step 2: CV (constant voltage 43.2V) charge till charge current decline to 0.05C.
Charging Time	2.5 Hours (Ref.)
Max. Charge Current	60A
Max. Discharge Current	60A (Peak 120A for 5 sec)
Operating temperature	Charging: 0°C to 45°C Discharging: -20°C to 55°C
Storage Temperature @ Humidity Range 45% ~ 90% RH	1 month: -20°C to 45°C 3 months: -10°C to 45°C 6 months: 0°C to 25°C The battery should cycle once in every 3 months. Recommended storage temperature is 25±5°C of SOC
Cycle Life	≥3000 cycles, more than 80% at 0.5C charge and 0.5C discharge at 80% DOD 25°C
Pack Initial Internal Impedance	≤100mΩ (50% SOC, measure the AC impedance at 1KHz)

LBS-3660

Voltage: 38.4V | Capacity: 60 Ah | Energy: 2304 Wh

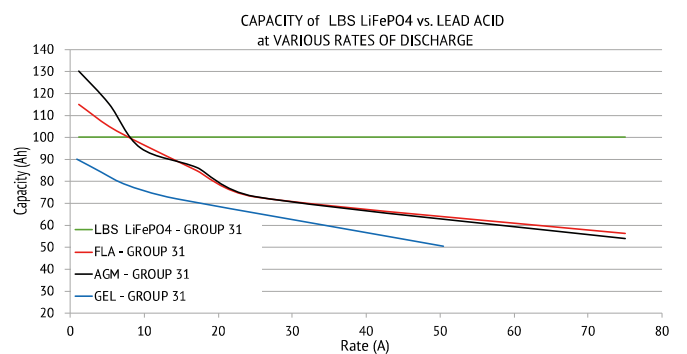
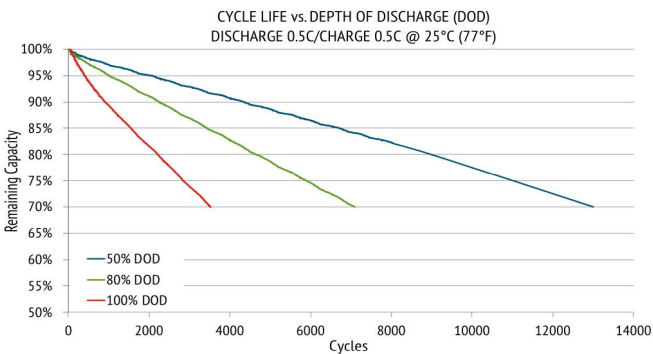
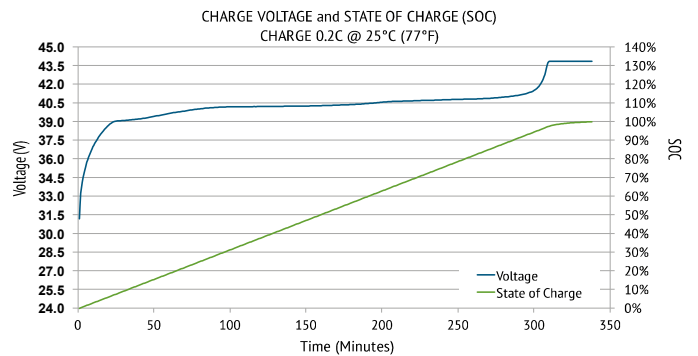
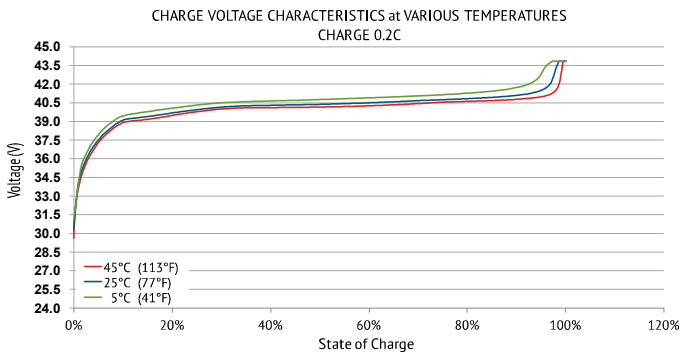
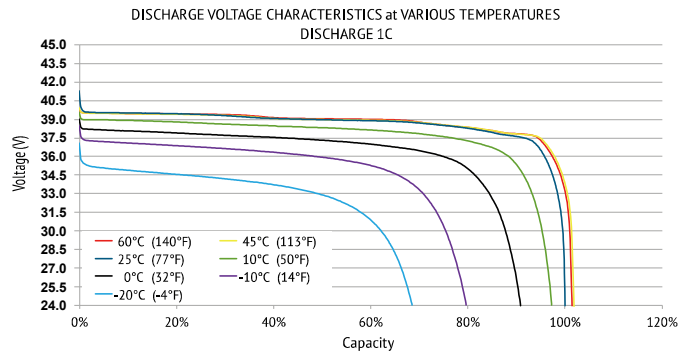
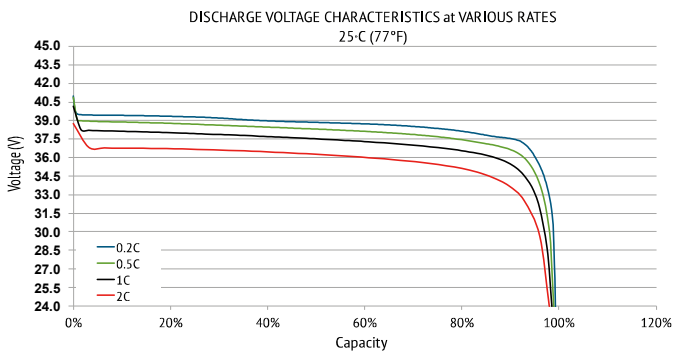
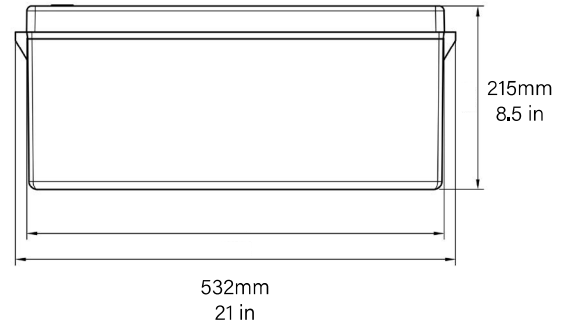
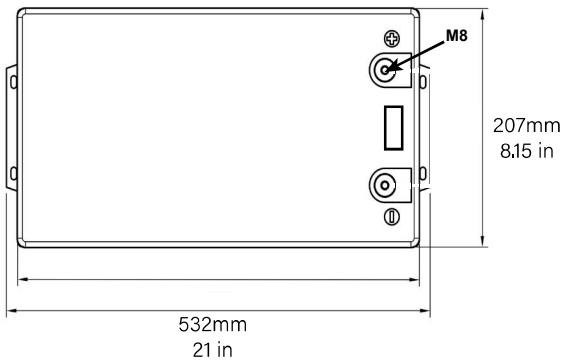

* The curve is only the reference of the comparison of discharge performance of Group31 batteries with different materials, might not for the specific model in the specs.

LBS-3660

Voltage: 38.4V | Capacity: 60 Ah | Energy: 2304 Wh



Caution

In order to prevent the battery possibly occurs leaks, over heat, swollen, please note the preventive measure.

Handling Precautions and Guideline

Strictly prohibits inverting the cathode use battery.

Strictly prohibits directly connect battery to power source plug

Please do not throw the battery to water or put into heater

Strictly prohibits plunging the battery in sea water or water, when battery do not use, please store battery in the cool-dry environment.

The prohibition in strong static electricity and strong magnetic field place use, otherwise is easy to destroy the battery BMS.

The prohibition puts the battery nearby the hot high temperature source, like the fire, the heater and so on use and leaves alone

The prohibition directly connects the battery cathode with the metal to short-circuit

The prohibition rap or throws, steps on the battery and so on

Forbids directly to weld the battery and pierces the battery with the nail or other sharp weapons

If the battery sends out the unusual smell, gives off heat, the distortion or appears any exceptionally, immediately moves the battery from the installment or the battery charger to and stops using.

If the battery occurs leaks, the electrolyte enters eye, please do not have to rub scratches, the application clear water flushing eye, and delivers the medical treatment otherwise to be able immediately to injure the eye

When battery long-term storage, or assembly in the host, suggest customer should take every 3 months carry-on one-time charge and discharge and recharge it to half-charge state

Abandon the battery to wrap up the electrode using the insulating paper, prevented the battery short-circuits.

Abandon battery processing to be supposed to follow the local government the laws and regulations.

Do not decompose the battery.